

AFLS 10H SC W

Network-compatible IP cabinet loudspeaker

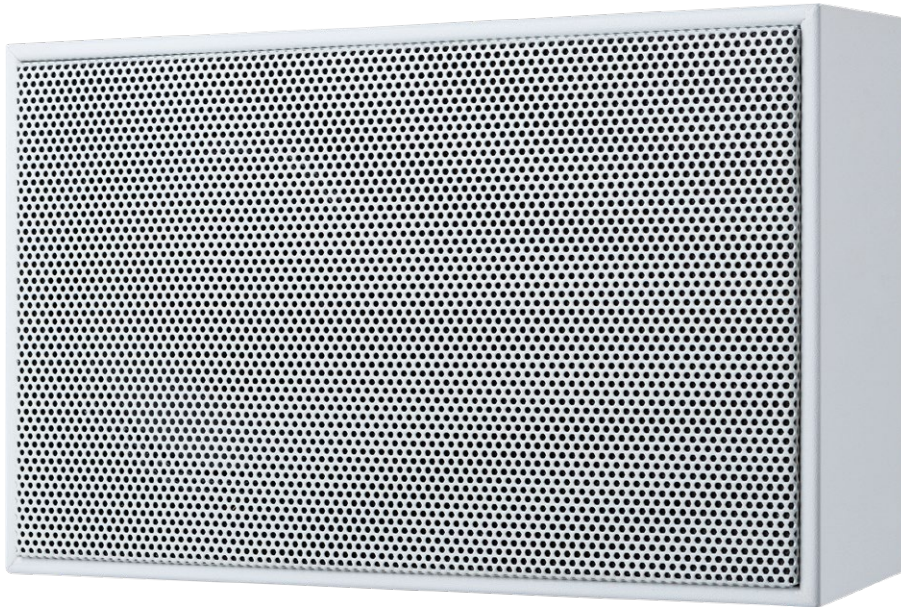

Fully
IP-based

Audio +
functionality

Rugged
housing

ONVIF
VMS
integration

16kHz
eHD Voice

Assertive in every situation

The IP cabinet loudspeaker AFLS 10H SC W is designed specifically to provide reliable voice signal transmission under indoor conditions (e.g. schools, meeting rooms and hotels).

As it can be used as IoIP device or as SIP device (hybrid), the loudspeaker integrates easily into any Voice over IP system as well as any existing Commend Intercom system.

Thanks to the built-in microphone and the IVC feature (Intelligent Volume Control), it is possible to adjust the volume automatically to the ambient noise – even during playback.

Features and highlights

- Each loudspeaker can be addressed and configured individually
- End-to-end monitoring of connection and loudspeaker functionality
- High volume capacity and superior speech quality thanks to the integrated 10 watt class-D amplifier and eHD Voice
- IVC (Intelligent Volume Control) automatically adjusts the volume setting to the ambient noise level
- Support of ONVIF Profile S for unidirectional audio transmission allows either audio announcements via a VMS (video management system) or audio streaming to a VMS
- Conversation and talk-back via the integrated microphone
- Audio monitoring enables ambient acoustic surveillance and automatic triggering of actions, such as voice announcements or emergency calls
- Built-in inputs and outputs, e.g. for monitoring and controlling third-party sub-sections or triggering predefined actions
- Power supply via PoE (Power over Ethernet) – only one Ethernet cable required
- No need for central amplifiers – ideal also for small-sized and remote PA zones
- Loudspeakers can be allocated to groups and zones without modifying the hardware or wiring
- Forward compatible (unlike classic PA systems), as new functions can easily be added via software download
- Combinable with virtual server landscapes via VirtuoSIS – provides all the benefits without the need for extra hardware

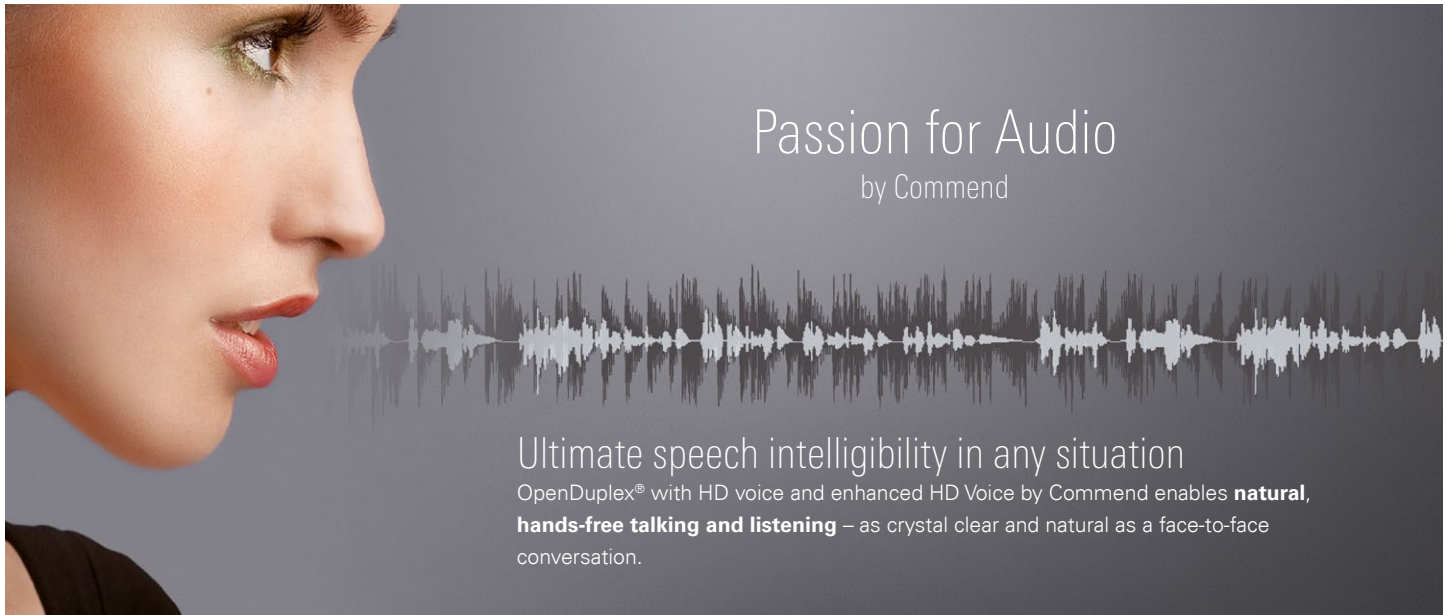





Passion for Audio

by Commend

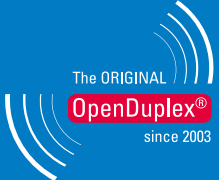
Ultimate speech intelligibility in any situation

OpenDuplex® with HD voice and enhanced HD Voice by Commend enables **natural, hands-free talking and listening** – as crystal clear and natural as a face-to-face conversation.

| | | | | |
|--|--|--|---|--|
|  <p>Natural communication</p> | <p>IVC</p> <p>Intelligent Volume Control</p> |  <p>High volume</p> |  <p>Background noise suppression</p> |  <p>Loudspeaker/microphone surveillance</p> |
|--|--|--|---|--|

Audio // Basics

| | |
|-------------------------|--|
| eHD Voice (IoIP) | Enhanced HD Voice by Commend transfers the audio signal at a bandwidth of 16 kHz , thus capturing the entire frequency spectrum of the human voice. |
| HD Voice (SIP) | HD Voice by Commend transfers the audio signal at a bandwidth of 7 kHz |
| Amplifier | Highly efficient class-D amplifier with 10 W |
| Microphone | Omnidirectional electret condenser microphone for max. 7 m (23 ft) speaking distance |
| Loudspeaker | 4 Ω loudspeaker with humidity-resistant special membrane type for optimum sound quality |

Learn more

audio.commend.com

Audio // Functions

| | IoIP | SIP |
|--|-------------------------------------|---|
| Dynamic background noise suppression virtually eliminates all ambient noise | | <input checked="" type="checkbox"/> |
| Loudspeaker-microphone surveillance – ensures the availability of the Intercom station while reducing the need for manual verification of its functionality | <input checked="" type="checkbox"/> | <input checked="" type="checkbox"/> |
| Audio monitoring – fully automated emergency calls triggered by defined noise levels for more security | <input checked="" type="checkbox"/> | <input checked="" type="checkbox"/> |
| Peer-to-peer audio – reduces network and server load to ensure efficient use of resources | <input checked="" type="checkbox"/> | <input checked="" type="checkbox"/> |
| Audio recording and lip synchronous audio/video recording of conversations for documentation and evidence keeping purposes | <input checked="" type="checkbox"/> | <input checked="" type="checkbox"/> ¹⁾ |
| Conference call function for simultaneous talking with multiple conversation partners | <input checked="" type="checkbox"/> | <input checked="" type="checkbox"/> |
| Speech activity detection senses when calls are finished (no microphone signal) and terminates the connection automatically | <input checked="" type="checkbox"/> | |
| Simplex mode for applications requiring controlled communication – e.g. for security solutions based on the “push-to-talk/release-to-listen” method | <input checked="" type="checkbox"/> | |
| OpenDuplex® for natural, hands-free communication | <input checked="" type="checkbox"/> | <input checked="" type="checkbox"/> |
| IVC (Intelligent Volume Control) automatically adjusts the device's volume setting to the ambient noise level | <input checked="" type="checkbox"/> | <input checked="" type="checkbox"/> |
| Public address functions | <input checked="" type="checkbox"/> | <input checked="" type="checkbox"/> ²⁾ |

¹⁾ Audio recording option on a compatible VMS via ONVIF Profile S.

²⁾ Public address functions via multicast or ONVIF Profile S announcements from a compatible VMS.

Example of use



Schools and cafeterias

Pupils and teacher who daily use one of the numerous schools all around the world trust on being safe and well informed. In practice, however, this is not always the case: important announcements are often drowned out by the noise that is caused by a high amount of people. This is because common public address systems cannot be adapted to the ambient noise. If the ambient noise level increases suddenly, announcements become acoustically unintelligible.

The Commend audio function IVC (Intelligent Volume Control) adjusts the loudspeaker volume automatically to the ambient noise level during voice announcements and when playing back pre-recorded messages. The result is a superior level of intelligibility – even at extremely high ambient noise levels. But how does it work?

The technical process behind IVC

IVC automatically adjusts the volume level of the loudspeaker to the current ambient noise conditions if the sound pressure level exceeds 60 dB. The loudspeaker's basic volume level setting defines the required minimum level, which depends on the average local noise pollution level. In case of a sharp increase in ambient noise (as caused by a starting or moving car), IVC automatically increases the volume setting as needed by up to four levels. The highest possible adjustment results are achieved at ambient noise levels of around 85 dB.

Volume level change during an announcement

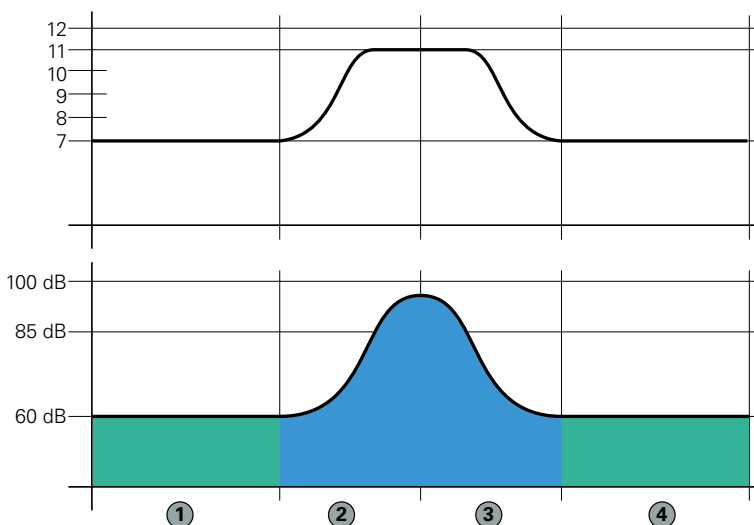

- 1 Standard sound pressure level at approx. 60 dB: the announcement is made with the configured volume level (in this example level "7").
- 2 The break begins, the sound pressure level rises above 60 dB: during the announcement, the volume level increases automatically (in this example by the maximum of four levels).
- 3 The break ends, the sound pressure level decreases back to 60 dB: during the announcement, the volume level is automatically reduced (in this example to the default level).
- 4 Standard sound pressure level again at approx. 60 dB: the announcement is made with the configured volume level (in this example level "7").

AFLS 10H SC W

Technical specifications

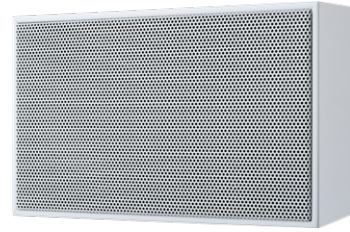

Technical data

| | |
|--|---|
| Loudspeaker: | 15 W, 4 Ω |
| Loudspeaker frequency range: | 70 Hz to 19 kHz (-10 dB) |
| Sound pressure level: | max. 102 dB (1 m/3.3 ft) |
| IoIP transmission bandwidth: | 16 kHz |
| SIP transmission bandwidth: | 7 kHz |
| Loudspeaker transmission angle: | 180° |
| ONVIF specification: | ONVIF Profile S for unidirectional audio |
| Microphone: | internal microphone: electret condenser microphone polar pattern: omnidirectional |
| Amplifier: | integrated class-D amplifier with 10 W |
| Inputs: | 2 inputs for floating contacts (IoIP: detection of 5 input states) |
| Outputs: | 2 relay outputs ¹⁾ max. 60 W (DC)/37.5 VA (AC), max. 2 A, max. 60 VDC/30 VAC expected life: min. 5 x 10 ⁴ (2 A), 10 ⁵ (1 A) |
| Connections: | spring clamp terminals IP uplink: shielded RJ45 modular jack |
| Power supply ²⁾: | PoE (Power over Ethernet): IEEE 802.3af standard power consumption: Class 0 (0.44 W to 12.96 W) |
| Cabling: | min. Cat. 5 |
| Approvals and compliances: | EN 55032 Class A, EN 55024 EN 60950-1, EN 62368-1 Clause 8 FCC Part 15 Class A, ICES-003 Class A |
| Protocols (IoIP): | IPv4, UDP, DHCP, RTP, RTCP, SNMPv2c, SNMPv4 |
| Protocols (SIP): | IPv6, IPv4, TCP, UDP, HTTP (RFC 2617, RFC 3310), RTP (RFC 3550), TLS, SRTP, RTCP, DHCP, STUN, TFTP, SDP (RFC 2327), SIP (RFC 3261), SNMPv2, URI (RFC 2396), DTMF Decoding (RFC 2876, RFC 2833), SIP User Agent (UDP RFC 3261), SIP Refer Method (RFC 3515) |
| Audio codecs (SIP): | G.711 a-Law, G.711 μ-Law, G.722 |
| Data rate: | 10/100 MBit/s (Full/Half Duplex) Auto MDIX |
| Operating temperature range: | -40 °C to +65 °C (-40 °F to +149 °F) |
| Storage temperature range: | -40 °C to +70 °C (-40 °F to +158 °F) |
| Colour: | white (RAL 9010) |
| Dimensions (W x H x D): | 265 x 165 x 88 mm (11.2 x 6.5 x 3.5 in) |
| Weight incl. package: | approx. 1.490 g (3.28 lbs) |

Line length in LAN

The maximum line length of Cat. 5 cabling in a LAN is 100 m (328 ft) – e.g. from switch to Intercom station.

Extent of supply

- IP cabinet loudspeaker
- Mounting bracket
- Device identification document
- Short reference

Note:

The rear of the loudspeaker housing is open and will be closed when mounted flush with a wall or ceiling surface. A separate cover is available as an optional accessory. The integrated electronics are contained in a separate housing for protection against external interference.

System requirements

IoIP

Intercom Server

- GE 800 (min. PRO 800 5.0, min. base licence PRO 1) with G8-IP or
- GE 300 (min. PRO 800 5.0, min. base licence PRO 1) with G3-IP or
- IS 300/G8-IP-32 (min. PRO 800 5.0, min. base licence PRO 1) or
- VirtuoSIS (min. PRO 800 5.0, min. base licence PRO 3)

Configuration software

- min. CCT 800 9.1 Build 1006
- IP Station Config (included in setup of CCT 800 9.1)
- min. Set-UP 1.4

SIP

- VirtuoSIS (min. PRO 800 5.0, min. base licence PRO 3) or
- Compatible SIP server (see compatibility list “**Interoperability SIP**”) or
- Serverless

¹⁾ The relay output may only be connected to an ES1 or a SELV circuit! An ES1 circuit as per IEC/EN/UL 62368-1 or a SELV circuit as per IEC/EN 60950-1 must be separated safely from a dangerous electrical circuit (e.g. 230 V or 110 V mains power), e.g. by means of double insulation. The ES1 or SELV circuit must not exceed 60 VDC or 42.4 VAC_{peak} (30 VAC_{eff})!

²⁾ Use PoE network switch or PoE injector only. PoE acc. IEEE 802.3af; output voltage 36–57 VDC; min. 12.95 W (per Ethernet port); LPS/PS2 or Class 2 output (IEC/EN/UL 62368-1).

Network requirements for use as SIP device

Ports

- The configuration via the web interface is done via TCP port "80" (cannot be configured).
- The communication from the SIP device to the SIP server is done via the following ports (both are configurable):
 - SIP: UDP port "5060"
 - RTP: UDP port "16384" (incoming)

Network requirements for use as VoIP device

IP addresses and ports

- For the AFLS 10H SC W, the DHCP functionality is available. If DHCP is not used, the AFLS 10H SC W must have a fixed IP address.
- In case of a changing public IP address, a dynamic registration of an AFLS 10H SC W is possible.
- The communication from the software IP Station Config is done via port "16399" (cannot be configured).
- The communication from the AFLS 10H SC W to the Intercom Server (UDP protocol) is done via port "16400" (configurable).

QoS requirements

- Maximum one-way delay 100 ms
- Delay-Jitter not above 50 ms
- 0% packet loss for perfect audio quality

Bandwidth

For further information on bandwidth, see guideline "**VoIP Technology**".

AFLS 10H SC W

Installation instructions

Safety instructions

- This device is intended to be mounted, handled and used by skilled persons only.
- Install or store this device out of the reach of children and do not allow persons unfamiliar with the device and these instructions to handle and operate the device.
- When opening the device, ESD precautions must be observed.
- Disconnect the Ethernet connector for any maintenance of the device.
- Before using the device, ensure all cables are connected correctly and not damaged.
- Do not make any modifications to the device and do not open the housing.
- Devices belonging to another earthing network must not be connected to the device's connectors.
- The device and connectors are subject to possible high transient voltage surges. The device is intended for appropriate installation to be mounted internally in locations where uninsulated conductors are not accessible to the operator.
- All connected circuits shall fulfil the requirements for Safety Extra Low Voltage (SELV) and Limited Power Source (LPS) according to IEC/EN 60950-1 and the requirements for ES1, PS2 circuits and Annex Q (Limited Power Source) as per IEC/EN/UL 62368-1.
- All changes or modifications not expressly approved by the party responsible for compliance could void the user's authority to operate the equipment.
- This is a Class A product (standard EN 55032). In a domestic environment this product may cause radio interference in which case the user may be required to take adequate measures.
- This equipment has been tested and found to comply with the limits for a Class A digital device, pursuant to part 15 of the FCC rules. These limits are designed to provide reasonable protection against harmful interference when the equipment is operated in a commercial environment. This equipment generates, uses and can radiate radio frequency energy and, if not installed and used in accordance with the instruction manual, may cause harmful interference to radio communications. Operation of this equipment in a residential area is likely to cause harmful interference in which case the user will be required to correct the interference at his own expense.

Mounting instructions

- Do not install the device on unstable walls or on surfaces which cannot support the device's weight.
- When using dowels, make sure to clean the wall holes properly after drilling.
- The device shall only be used indoors.
- Do not place the device in areas where it may become wet or damp, and avoid dusty, humid and high temperature environments ("Technical data", see TE | 1).
- The Ethernet cable shall only be connected to an inside network environment where over-voltage transients are not likely.
- Use shielded Ethernet cables only.
- Observe the country specific standards for installation, mounting and configuration.
- The required tightening torque for the two adjusting screws is 0.3 Nm.

Dimensions

Measuring units in mm (in), not to scale!

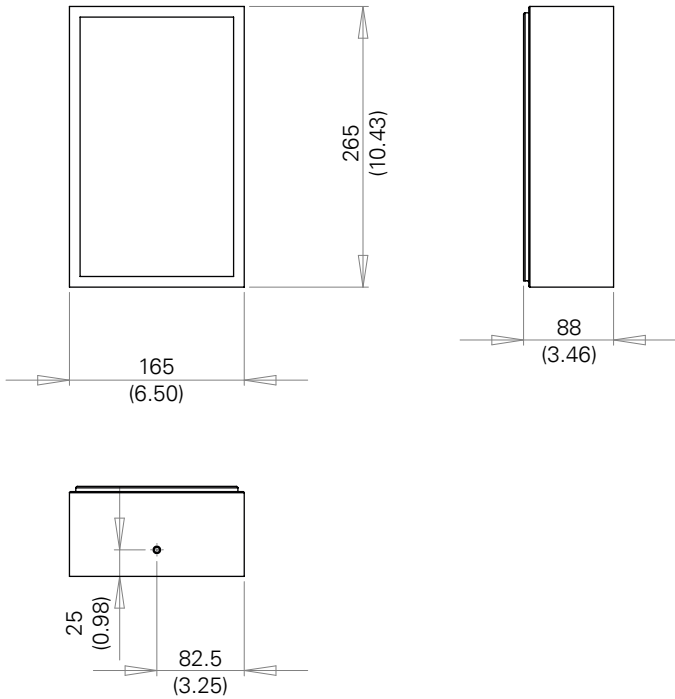

Locking the mounting bracket

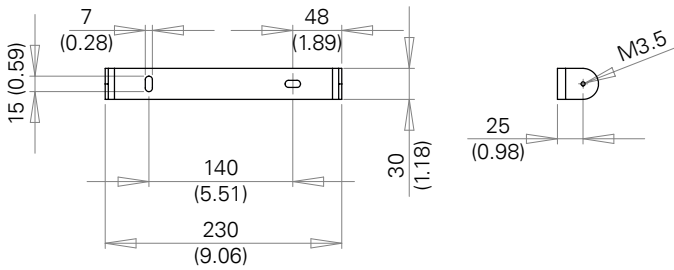

Connection (rear view)

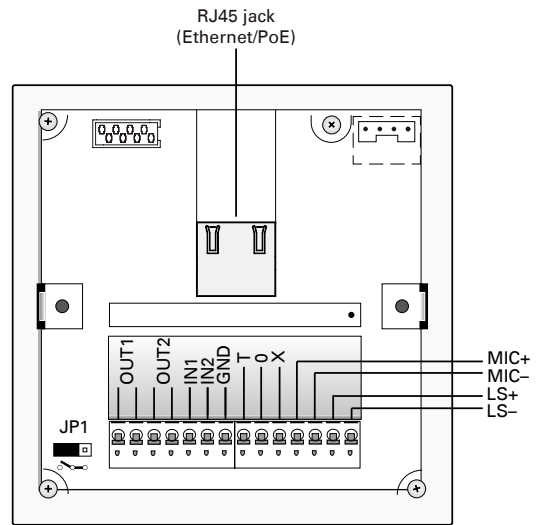

Note

- **OUT 1** is factory adjusted as normally open contact. Via the jumper JP1, the output can be converted into a normally closed contact.
- **OUT 2** is factory adjusted as normally open contact.
- PoE required (see "Technical data" on page TE | 1).

Attention

The spring clamp terminal will be damaged when inserting a screwdriver into the cable opening.

AFLS 10H SC W

Complementary information

Configuration via IP Station Config

Follow the steps below to operate the AFLS 10H SC W either as SIP or VoIP device:

- Click on **Query stations** to indicate all subscribers within the network.
- In the column **BootMode**, select the operation mode of the AFLS 10H SC W. The following options are available:
 - **Boot as SIP**: The AFLS 10H SC W operates as SIP device.
 - **Boot as VoIP**: The AFLS 10H SC W operates as VoIP device.

Configuration via CCT 800

General configuration

Before setting up the AFLS 10H SC W, follow the steps below:

- Receive the current configuration.
- Go to: **Subscriber > Station properties > IP-Terminals**
- Carry out the IP configuration for the AFLS 10H SC W.

Volume Configuration

If the call mode OpenDuplex® is configured, it is recommended to set the volume level to maximum "7". For this, follow the steps below:

- Go to: **Subscriber > Audio - Features > tab Duplex, Simplex, Full Duplex**
- In the drop-down list **Full Duplex limit**, select the option "7".

To enable the best call comfort, it is recommended to activate the IVC function ("Intelligent Volume Control"). For this, follow the steps below:

- Go to: **Subscriber > DSP-Features > tab voice control**
- Make sure the checkbox **IVC** is activated.

Note

For further information on configuring via CCT 800, see manual "**Intercom Server Configuration**".

Configuration in via web interface

In operation mode as SIP device, the internal microphone of the AFLS 10H SC W is set per default.

Quality tested. Reliable. Smart.

COMMEND products are developed and manufactured by Commend International in Salzburg, Austria.

The development and manufacturing processes are certified in accordance with **EN ISO 9001:2015**.



The technical data contained herein has been provided solely for informational purposes and is not legally binding. Subject to change, technical or otherwise. VoIP®, OpenDuplex® and Commend® are trademarks registered by Commend International GmbH. All other brands or product names are trademarks or registered trademarks of the respective owner and have not been specifically earmarked.

A strong worldwide network

COMMEND is represented all over the world by local Commend Partners and helps to improve security and communication with tailored Intercom solutions.

www.commend.com