

ET 962HR / ET 970HR

Compact IP Intercom modules for raw environments and railway applications

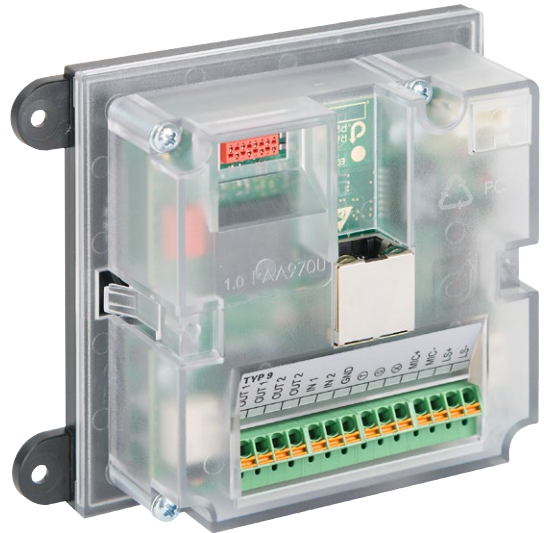

EN 50155
compliant

16 kHz
eHD Voice

High
volume

Rugged
housing

Fully
IP-based

The perfect built-in solution

The hybrid Intercom modules ET 962HR and ET 970HR have been developed for installation in existing housings or for construction of special Intercom terminals. As they support both VoIP connections and SIP solutions (hybrid), the Intercom modules can easily be integrated into any Voice over IP system as well as any existing Comend Intercom system. The desired operation mode is selected via the configuration software.

Applications for the Intercom modules ET 962HR and ET 970HR are all kinds of call and emergency call stations, where the station is built-in and only an external call button is used. This means, special solutions for e.g. emergency call pillars, elevator cabins, ticketing machines or barriers at entrances and exits can be created, which optimally satisfy function and optical appearance of the customer specifications.

These EN 50155 certified Intercom modules are perfectly suited for rolling stock and railway applications. Furthermore, the modules can be used as door stations at entrance areas and gateways, due to two integrated relay outputs.

Features and highlights

- High volume capacity and superior speech quality, thanks to class-D amplifier and eHD Voice
- Built-in inputs and outputs for connection of e.g. door openers – can be extended via expansion jack
- One compact and robust housing with single RJ45 connector for easy installation
- Coated boards for raw environments and railway applications
- Intercom modules are certified according to standard EN 50155
- Spring clamp terminals provide an easy and fast cable connection
- Special audio functions ensure superior speech quality in any situation
- The high-sensitivity microphone supports speaking distances of up to 7 m, making the device ideally suited, e.g. for wheelchair users
- Sound output or playback of pre-recorded messages can be used to provide information and reassurance to callers
- Ready for connection of induction loop systems, which enables persons wearing hearing aids with an induction loop to receive Intercom audio signals in clear, uninterrupted quality

Key benefits at a glance

Extreme temperature fluctuation, high humidity, shocks and vibration: the rugged ABS housing withstands rough operating conditions.

The compact design enables an easy installation in existing housings or panels.

The multifunctional LEDs can be configured individually to various device states.

ET 962HR: The built-in loudspeaker supports high audio volumes and superior acoustic intelligibility; audio output or playback of pre-recorded messages can be used to provide information and reassurance to callers.

The built-in high-sensitivity electret condenser microphone supports speaking distances of up to 7 m from the microphone, making the device ideally suited e.g. for wheelchair users.

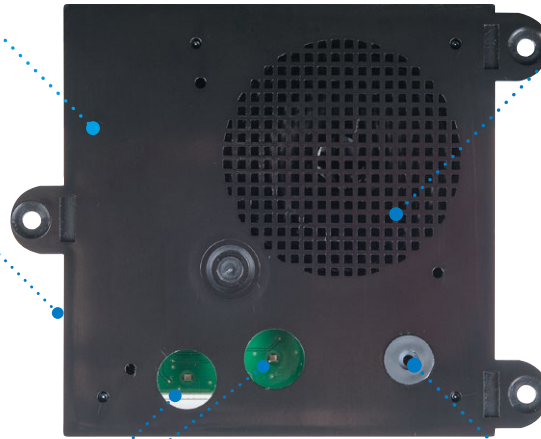

Via the expansion jack, it is possible to connect e.g. additional input/output contacts.

Durable and reliable: a protection layer protects the circuit board from corrosion and surface impurity

Spring clamp terminals for electrical connection without tools.

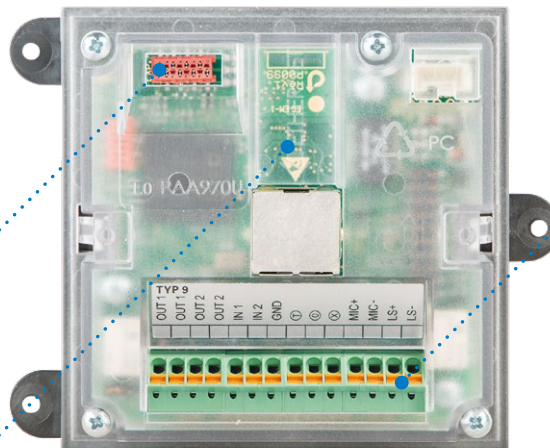

Module versions

ET 962HR

- Built-in loudspeaker
- Built-in microphone

ET 970HR

- Without built-in loudspeaker
- Built-in microphone and installation microphone MIC 480 included in extent of supply

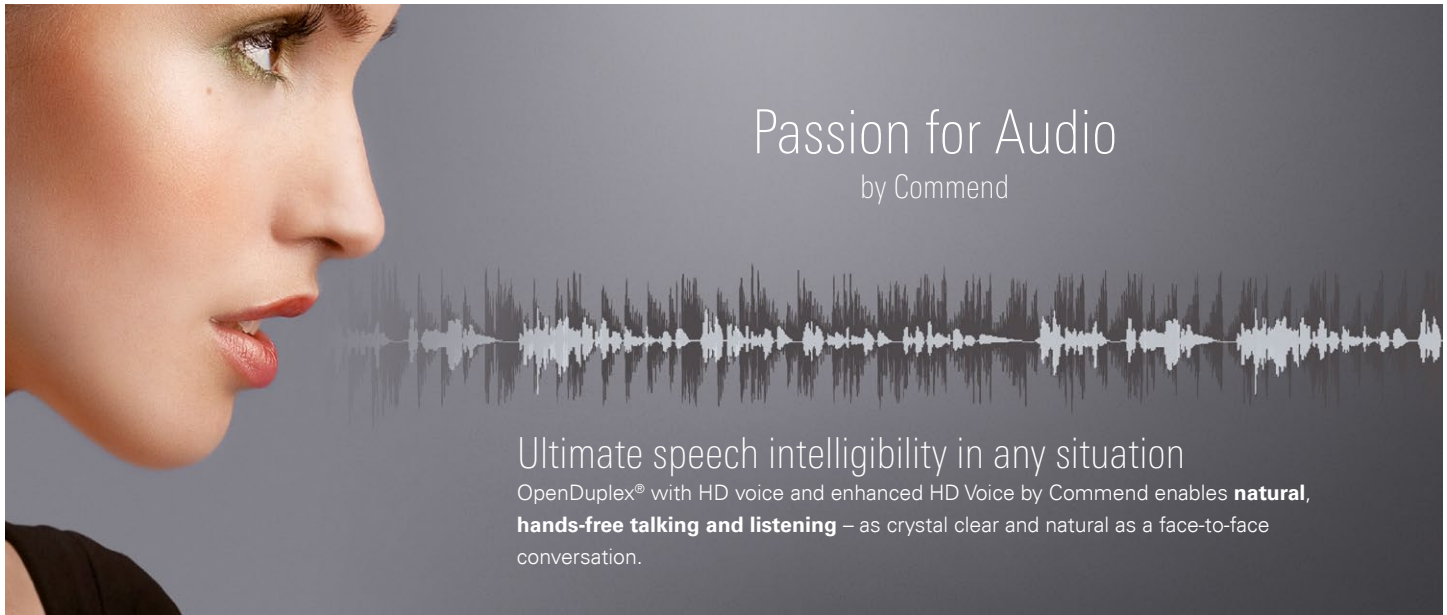





Passion for Audio

by Commend

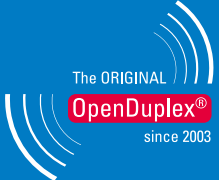
Ultimate speech intelligibility in any situation

OpenDuplex® with HD voice and enhanced HD Voice by Commend enables **natural, hands-free talking and listening** – as crystal clear and natural as a face-to-face conversation.

 <p>Natural communication</p>	<p>IVC</p> <p>Intelligent Volume Control</p>	 <p>High volume</p>	 <p>Background noise suppression</p>	 <p>Loudspeaker/microphone surveillance</p>
--	--	--	---	--

Audio // Basics

eHD Voice (IoIP)	Enhanced HD Voice by Commend transfers the audio signal at a bandwidth of 16 kHz , thus capturing the entire frequency spectrum of the human voice.
HD Voice (SIP)	HD Voice by Commend transfers the audio signal at a bandwidth of 7 kHz
STI	Speech Transmission Index 0.96 – measured under acoustic laboratory conditions (STI is a standard measure for speech intelligibility; it has a possible maximum value of 1.00, which corresponds to perfect intelligibility)
Amplifier	Highly efficient class-D amplifier
Microphone	Omnidirectional electret condenser microphone for max. 7 m (23 ft) speaking distance
Loudspeaker	ET 962HR: 8 Ω loudspeaker with humidity-resistant special membrane type for optimum sound quality

Learn more

audio.commend.com

Audio // Functions

	IoIP	SIP
Dynamic background noise suppression virtually eliminates all ambient noise		<input checked="" type="checkbox"/>
Loudspeaker-microphone surveillance – ensures the availability of the Intercom station while reducing the need for manual verification of its functionality	<input checked="" type="checkbox"/>	<input checked="" type="checkbox"/>
Audio monitoring – fully automated emergency calls triggered by defined noise levels for more security	<input checked="" type="checkbox"/>	<input checked="" type="checkbox"/>
Peer-to-peer audio – reduces network and server load to ensure efficient use of resources	<input checked="" type="checkbox"/>	<input checked="" type="checkbox"/>
Audio recording and lip synchronous audio/video recording of conversations for documentation and evidence keeping purposes	<input checked="" type="checkbox"/>	<input checked="" type="checkbox"/> ¹⁾
Conference call function for simultaneous talking with multiple conversation partners	<input checked="" type="checkbox"/>	<input checked="" type="checkbox"/>
Speech activity detection senses when calls are finished (no microphone signal) and terminates the connection automatically	<input checked="" type="checkbox"/>	
Simplex mode for applications requiring controlled communication – e.g. for security solutions based on the “push-to-talk/release-to-listen” method	<input checked="" type="checkbox"/>	
OpenDuplex® for natural, hands-free communication	<input checked="" type="checkbox"/>	<input checked="" type="checkbox"/>
IVC (Intelligent Volume Control) automatically adjusts the device's volume setting to the ambient noise level	<input checked="" type="checkbox"/>	<input checked="" type="checkbox"/>
Public address functions	<input checked="" type="checkbox"/>	<input checked="" type="checkbox"/> ²⁾

¹⁾ Audio recording option on a compatible VMS via ONVIF Profile S.

²⁾ Public address functions via multicast or ONVIF Profile S announcements from a compatible VMS.

ET 962HR / ET 970HR

Technical specifications

Technical data

Microphone:	electret condenser microphone polar pattern: omnidirectional ET 970HR: electret condenser microphone (MIC 480), included in extent of supply
Loudspeaker (ET 962HR only):	special membrane type for optimal sound quality, sound pressure level: 85 dB / 1 W / 1 m (3.28 ft), 8 Ω possibility for connection of an external loudspeaker: ET 962HR: 8 to 50 Ω ET 970HR: 4 to 50 Ω
Amplifier:	integrated class-D amplifier, 10 W ET 962HR: integrated class-D amplifier, max. 1.2 W (for the built-in loudspeaker)
Input:	2 inputs for floating contacts (IoIP: detection of 5 input states)
Output:	2 relay outputs (1 switch-over contact, 1 normally open contact) max. 60 VDC, 2 A, 60 W ¹⁾ expected life: min. 5 x 10 ⁶ (2 A), 10 ⁶ (1 A)
Keypad:	possibility for connection of 3 single buttons (T, O, X)
IoIP transmission bandwidth:	16 kHz
SIP transmission bandwidth:	7 kHz
Operating temperature range:	-40 °C to +70 °C (-40 °F to +158 °F)
Storage temperature range:	-40 °C to +70 °C (-40 °F to +158 °F)
Relative humidity:	up to 95 %, not condensing
Connection:	spring clamp terminals, expansion jack, e.g. for EB2E2AHE, IP Uplink: shielded RJ45 jack
Power supply ²⁾:	PoE (Power over Ethernet): IEEE 802.3af standard power consumption of the terminal device: Class 0 (0.44 W to 12.96 W)
Cabling:	min. Cat. 5
Protocols (IoIP):	IPv4, UDP, DHCP, RTP, RTCP, SNMPv2c, SNTpv4
Protocols (SIP):	IPv6, IPv4, TCP, UDP, HTTP (RFC 2617, RFC 3310), RTP (RFC 3550), TLS, SRTP, RTCP, DHCP, STUN, TFTP, SDP (RFC 2327), SIP (RFC 3261), SNMPv2, URI (RFC 2396), DTMF Decoding (RFC 2876, RFC 2833), SIP User Agent (UDP RFC 3261), SIP Refer Method (RFC 3515)
Codecs (SIP):	G.711 a-Law G.711 μ-Law G.722
Data rate:	10/100 MBit/s (Full / Half Duplex) Auto MDIX
Dimensions:	front panel: 88 x 109 mm (3.46 x 4.29 in) mounting depth: 41 mm (1.6 in)
Weight incl. package:	approx. 220 g (0.4 lbs)

¹⁾ The relay output may only be connected to an ES1 or a SELV circuit! An ES1 circuit as per IEC/EN/UL 62368-1 or a SELV circuit as per IEC/EN 60950-1 must be separated safely from a dangerous electrical circuit (e.g. 230 V or 110 V mains power), e.g. by means of double insulation. The ES1 or SELV circuit must not exceed 60 VDC or 42.4 VAC_{peak} (30 VAC_{rms})!

²⁾ Use PoE network switch or PoE injector only. PoE acc. IEEE 802.3af; output voltage 36–57 VDC; min. 12.95 W (per Ethernet port); LPS/PS2 or Class 2 output (IEC/EN/UL 62368-1).

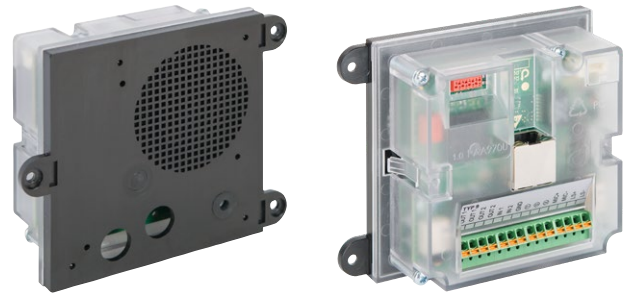

Line length in LAN

The maximum line length of Cat.5 cabling in a LAN is 100 m (328 ft) – e.g. from switch to the Intercom station.

Extent of supply

- Intercom module
- Light pipe and plexiglass LED cover, optionally as light guide for the multifunction LED
- Claiming code
- Open source compliance information
- Short reference
- ET 970HR only: electret condenser microphone MIC 480, cable length 4 m (3.12 ft)

System requirements

IoIP

Intercom Server

- GE 800 (min. PRO 800 6.1, min. base licence PRO 1) with G8-IP or
- GE 300 (min. PRO 800 6.1, min. base licence PRO 1) with G3-IP or
- IS 300 / G8-IP-32 (min. PRO 800 6.1, min. base licence PRO 1) or
- VirtuoSIS (min. PRO 800 6.1, min. base licence PRO 3)

Configuration software

- Min. CCT 800 6.1
- IP Station Config (included in setup of CCT 800)

SIP

- VirtuoSIS (min. version 5.0) or
- S3/S6 (min. version 7.1) or
- Compatible SIP server (see compatibility list “**Interoperability SIP**”) or
- Serverless operation

Network requirements: operation as SIP device

Ports

- The configuration via the web interface is done via TCP port 80 (cannot be configured).
- The communication from the SIP device to the SIP server is done via the following ports (both are configurable):
 - SIP: UDP port 5060
 - RTP: UDP port 16384 (incoming)

Network requirements: operation as VoIP device

IP addresses and ports

- For the ET 962HR / ET 970HR, the DHCP functionality is available.
If DHCP is not used, the ET 962HR / ET 970HR must have a fixed IP address.
- In case of a changing public IP address, dynamic registration of an ET 962HR / ET 970HR is possible.
- Communication from the program IP Station Config is done via Port 16399 (cannot be configured).
- Communication from the ET 962HR / ET 970HR to the Intercom Server (UDP protocol) is done via port 16400 (configurable).

QoS requirements

- Maximum one-way delay 100 ms
- Delay-Jitter not above 50 ms
- 0% packet loss for perfect audio quality

Bandwidth

- For further information, see guideline "VoIP Technology".

Connection

Rear view

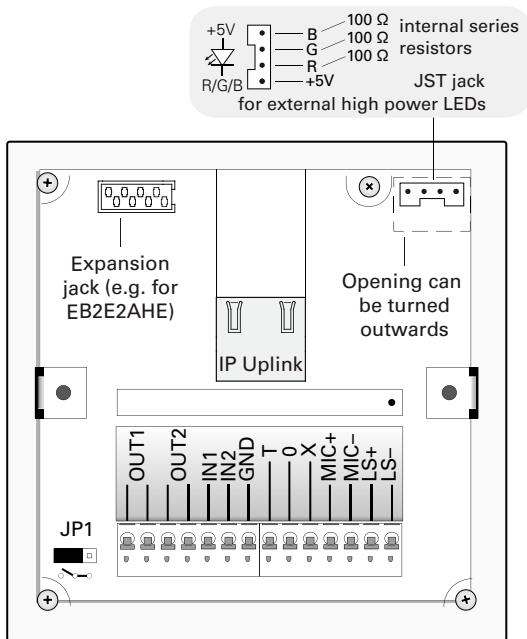

Notes

- OUT 1 factory adjusted as normally open contact. With the jumper JP1, it can be converted into a normally closed contact.
- OUT 2 factory adjusted as normally open contact.
- PoE (“Power over Ethernet”): IEEE 802.3af standard. Power consumption of the terminal device: Class 0.
- The internal microphone will be deactivated as soon as an external microphone is connected.
- Possibility for connection of an external loudspeaker:
ET 962HR: 8 to 50 Ω (works in parallel with the internal loudspeaker)
ET 970HR: 4 to 50 Ω
- Push-in connections for rigid cables and flexible cables with ferrules.

Attention

The spring clamp terminal will be damaged when inserting a screwdriver into the cable opening!

Quality tested. Reliable. Smart.

COMMEND products are developed and manufactured by Commend International in Salzburg, Austria.

The development and manufacturing processes are certified in accordance with **EN ISO 9001:2015**.



The technical data contained herein has been provided solely for informational purposes and is not legally binding. Subject to change, technical or otherwise. lolP®, OpenDuplex® and Commend® are trademarks registered by Commend International GmbH. All other brands or product names are trademarks or registered trademarks of the respective owner and have not been specifically earmarked.

A strong worldwide network

COMMEND is represented all over the world by local Commend Partners and helps to improve security and communication with tailored Intercom solutions.

www.commend.com